



VX-261

OPERATING MANUAL

PROGRAMMABLE FUNCTIONS/FEATURES

- IP55 Water Resistant
- Two Programmable Function Keys
- 2-Tone Encode/Decode
- 5-Tone Encode/Decode
- MDC-1200® Encode (ANI Encode)
- DTMF Encode
- Scan
- Dual Watch
- Follow-Me Scan
- Talk Around Scan
- VOX
- Talk Around
- Emergency
- Lone Worker
- TX Save Disable
- Lock
- ARTS™ (Auto Range Transpond System)

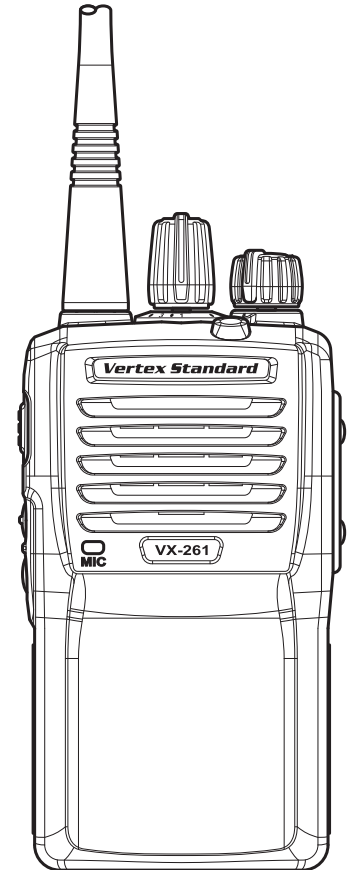

CONTENTS

Introduction	1	Operation	10
Warning! FCC RF Exposure Requirements	2	Preliminary Steps	10
Warning! IC RSS General Requirement	4	Operation Quick Start.....	10
Before You Begin	6	Automatic Time-Out Timer.....	12
Battery Pack Installation and Removal.....	6	Advanced Operation	13
Battery Charging	6	Programmable Key Functions	13
Low Battery Indication.....	7	Description of Operating Functions	14
Belt Clip Installation and Removal	8	Lock	19
MIC/SP Cap Installation	8	ARTS™ (Auto Range Transpond System)	19
Controls & Connectors	9	Optional Accessories	20

Congratulations!

You now have at your fingertips a valuable communications tool, a Vertex Standard two-way radio! Rugged, reliable and easy to use, your Vertex Standard radio will keep you in constant touch with your colleagues for years to come, with negligible maintenance down-time. Please take a few minutes to read this manual carefully. The information presented here will allow you to derive maximum performance from your radio, in case questions arise later on.

Important Note

- There are no owner-serviceable parts inside the radio. All service jobs must be referred to an authorized Vertex Standard Service Representative.
- In order to maintain the specified water integrity performance, periodic maintenance is recommended.
- Should the radio sustain a severe shock (e.g. if it is dropped), the water integrity may be compromised, requiring service. Should this occur, contact your Authorized Vertex Standard Dealer.

INTRODUCTION

The **VX-261** is full-featured Hand-Held Analog Transceiver designed for business communications in the VHF/UHF Land Mobile bands. This transceiver is designed for reliable business communications in a wide variety of applications with a wide range of operating capability provided by their leading-edge design, and allows up to 16-channel capacity.

Important channel frequency data is stored in the flash memory, and is easily programmable by a Vertex Standard licensed dealers using a personal computer with Vertex Standard Programming equipment: **FIF-12** USB Programming Interface, and **CT-106** Connection cable with **CE150** PC Programming Software. Or, once a single radio is programmed, cloning cable **CT-27** can be used to program additional radios directly.

This manual will describe the details of the many advanced features of the **VX-261**. After reading this manual, you may wish to consult with your Network Administrator regarding precise details of the configuration of this equipment for use in your application.

Important Notice for North American Users Regarding 406 MHz Guard Band

The U.S. Coast Guard and National Oceanographic and Atmospheric Administration have requested the cooperation of the U.S. Federal Communications Commission in preserving the integrity of the protected frequency range 406.0 to 406.1 MHz, which is reserved for use by distress beacons. Do not attempt to program this apparatus, under any circumstances, for operation in the frequency range 406.0 - 406.1 MHz if the apparatus is to be used in or near North America.

Warning - Frequency band 406 - 406.1 MHz is reserved for use ONLY as a distress beacon by the US Coast Guard and NOAA. Under no circumstance should this frequency band be part of the pre programmed operating frequencies of this radio.

WARNING! FCC RF EXPOSURE REQUIREMENTS

This Radio has been tested and complies with the Federal Communications Commission (FCC) RF exposure limits for Occupational Use/Controlled exposure environment. In addition, it complies with the following Standards and Guidelines:

- ❑ FCC 96-326, Guidelines for Evaluating the Environmental Effects of Radio-Frequency Radiation.
- ❑ FCC OET Bulletin 65 Edition 97-01 (2001) Supplement C, Evaluating Compliance with FCC Guidelines for Human Exposure to Radio Frequency Electromagnetic Fields.
- ❑ ANSI/IEEE C95.1-1992, IEEE Standard for Safety Levels with Respect to Human Exposure to Radio Frequency Electromagnetic Fields, 3 kHz to 300 GHz.
- ❑ ANSI/IEEE C95.3-1992, IEEE Recommended Practice for the Measurement of Potentially Hazardous Electromagnetic Fields - RF and Microwave.

⚠ WARNING:

This radio generates RF electromagnetic energy during transmit mode. This radio is designed for and classified as **Occupational Use Only**, meaning it must be used only during the course of employment by individuals aware of the hazards, and the ways to minimize such hazards. This radio is not intended for use by the General Population in an uncontrolled environment.

⚠ CAUTION:

To ensure that your exposure to RF electromagnetic energy is within the FCC allowable limits for occupational use, always adhere to the following guidelines:

- **This radio is NOT approved for use by the general population in an uncontrolled exposure environment. This radio is restricted to occupational use, work related operations only where the radio operator must have the knowledge to control his or her RF exposure conditions.**
- **When transmitting, hold the radio in a vertical position with its microphone 1 inch (2.5 cm) away from your mouth and keep the antenna at least 1 inch (2.5 cm) away from your head.**
- **Transmit no more than the rated duty factor of 50% of the time. To transmit (talk), push the Push-To-Talk (PTT) button. To receive calls, release the PTT button. The PTT button may reside on the radio itself or may be hosted**

WARNING! FCC RF EXPOSURE REQUIREMENTS

on approved accessories. Transmitting 50% of the time, or less, is important because this radio generates measurable RF energy exposure only when transmitting (in terms of measuring for standards compliance).

The radio is transmitting when the red LED on the top of the radio is illuminated. You can cause the radio to transmit by pressing the P-T-T button.

- **In front of the face.** Hold the radio in a vertical position with the microphone (and other parts of the radio including the antenna) at least 1 inch (2.5 cm) away from the nose or lips. Keeping the radio at a proper distance is important to ensure compliance.
- **SAR compliance for body-worn use** was only demonstrated for the specific belt-clip (CLIP-20). Other body-worn accessories or configurations may NOT comply with the FCC RF exposure requirements and should be avoided.
- **Always use Vertex Standard authorized accessories.**
- **The information listed above provides the user with the information needed to make him or her aware of RF exposure, and what to do to assure that this radio operates with the FCC RF exposure limits of this radio.**
- **Electromagnetic Interference/Compatibility**

During transmissions, this radio generates RF energy that can possibly cause interference with other devices or systems. To avoid such interference, turn off the radio in areas where signs are posted to do so.

Do not operate the transmitter in areas that are sensitive to electromagnetic radiation such as hospitals, health care facilities, aircraft, and blasting sites.

WARNING! IC RSS GENERAL REQUIREMENT

ENGLISH

❑ Under Industry Canada regulations, this radio transmitter may only operate using an antenna of a type and maximum (or lesser) gain approved for the transmitter by Industry Canada. To reduce potential radio interference to other users, the antenna type and its gain should be so chosen that the equivalent isotropically radiated power (e.i.r.p.) is not more than that necessary for successful communication.

❑ This radio transmitter (identify the device by certification number, or model number if Category II) has been approved by Industry Canada to operate with the antenna types listed at the right with the maximum permissible gain and required antenna impedance for each antenna type indicated. Antenna types not included in this list, having a gain greater than the maximum gain indicated for that type, are strictly prohibited for use with this device.

VHF MODEL	UHF MODEL
ATV-8A: -2.15 dBi, 50-ohm	ATU-6A: -2.15 dBi, 50-ohm
ATV-8B: -2.15 dBi, 50-ohm	ATU-6B: -2.15 dBi, 50-ohm
ATV-8C: -2.15 dBi, 50-ohm	ATU-6C: -2.15 dBi, 50-ohm
ATV-6XL: -2.15 dBi, 50-ohm	ATU-6D: -2.15 dBi, 50-ohm
	ATU-6F: -2.15 dBi, 50-ohm

○ **When transmitting, hold the radio in a vertical position with its microphone 1 inch (2.5 cm) away from your mouth and keep the antenna at least 1 inch (2.5 cm) away from your head.**

○ **The radio must be used with a maximum operating duty cycle not exceeding 50%, in typical Push-to-Talk configurations.**

DO NOT transmit for more than 50% of total radio use time (50% duty cycle). Transmitting more than 50% of the time can cause IC RSS General Requirement to be exceeded. To keep the Body Worn configuration with the Vertex Standard CLIP-20 belt-clip, reduce the maximum operating duty cycle still more.

The radio is transmitting when the red LED on the top of the radio is illuminated. You can cause the radio to transmit by pressing the P-T-T button.

○ **SAR compliance for body-worn use was only demonstrated for the specific belt-clip (CLIP-20). Other body-worn accessories or configurations may NOT comply with the IC RSS General Requirement and should be avoided.**

WARNING! IC RSS GENERAL REQUIREMENT

FRENCH

- ❑ Conformément à la réglementation d'Industrie Canada, le présent émetteur radio peut fonctionner avec une antenne d'un type et d'un gain maximal (ou inférieur) approuvé pour l'émetteur par Industrie Canada. Dans le but de réduire les risques de brouillage radioélectrique à l'intention des autres utilisateurs, il faut choisir le type d'antenne et son gain de sorte que la puissance isotrope rayonnée équivalente (p.i.r.e.) ne dépasse pas l'intensité nécessaire à l'établissement d'une communication satisfaisante.
- ❑ Le présent émetteur radio (identifier le dispositif par son numéro de certification ou son numéro de modèle s'il fait partie du matériel de catégorie I) a été approuvé par Industrie Canada pour fonctionner avec les types d'antenne énumérés dans le droit et ayant un gain admissible maximal et l'impédance requise pour chaque type d'antenne. Les types d'antenne non inclus dans cette liste, ou dont le gain est supérieur au gain maximal indiqué, sont strictement interdits pour l'exploitation de l'émetteur.
- | VHF MODÈLE | UHF MODÈLE |
|----------------------------|---------------------------|
| ATV-8A: -2.15 dBi, 50-ohm | ATU-6A: -2.15 dBi, 50-ohm |
| ATV-8B: -2.15 dBi, 50-ohm | ATU-6B: -2.15 dBi, 50-ohm |
| ATV-8C: -2.15 dBi, 50-ohm | ATU-6C: -2.15 dBi, 50-ohm |
| ATV-6XL: -2.15 dBi, 50-ohm | ATU-6D: -2.15 dBi, 50-ohm |
| | ATU-6F: -2.15 dBi, 50-ohm |
- **Pour émettre, tenez votre radio verticalement en plaçant le microphone entre 2,5 et 5 cm de la bouche. L'antenne doit toujours être à plus de 2,5 cm de votre tête.**
- **Le temps total d'émission de la radio ne doit pas dépasser 50% du temps de fonctionnement dans une configuration normale avec alternat. Par conséquent, vous ne devez PAS émettre pendant plus de 50% du temps total d'utilisation de la radio. Si cette règle n'est pas respectée, vous exposez à un dépassement de l'exposition aux fréquences électromagnétiques telle que définie par la norme de sécurité. La radio émet lorsque le voyant LED rouge (situé au sommet de la radio) est allumé. Vous pouvez déclencher l'émission en appuyant sur le bouton Alternat ou avec un micro-casque VOX, si la radio permet d'utiliser cet accessoire.**
- **La conformité SAR pour utilisation sur le corps n'a été confirmée que pour l'attache ceinture de nomenclature CLIP-20. L'utilisation de tout autre accessoire pour port sur le corps PEUT être non conforme aux normes d'exposition aux radio-fréquences et doit donc être évitée.**
- **N'opérez pas votre radio en mode d'émission lorsque vous la portez fixée sur le corps à l'aide de l'accessoire suivant : CLIP-20 attache ceinture.**

BEFORE YOU BEGIN

Battery Pack Installation and Removal

- ❑ To install the battery pack, align the battery pack to the radio with an offset about 1/2 inch (1.5 cm) from the top edge of battery compartment, then slide the battery pack upward until it locks in place with a “Click.”

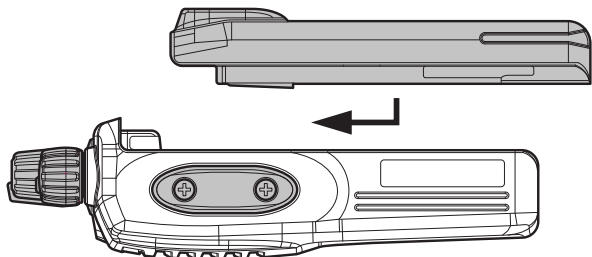

- ❑ To remove the battery, turn the radio off and remove any protective cases. Slide the Battery Pack Latch on the bottom of the radio toward the front panel while sliding the battery down about 1/2 inch (1.5 cm). Then lift the battery out from the radio.

 **Do not attempt to open any of the rechargeable Lithium-Ion packs, as they could explode if accidentally short-circuited.**

Battery Charging

- ❑ Remove the Spacer Plate from the nest of the optional **CD-58** Desktop Charger, if the Battery Spacer is installed.
- ❑ Insert the DC plug from the optional **PA-55** AC Adapter into the DC jack on the rear panel of the optional **CD-58** Desktop Charger, and then connect the **PA-55** AC Adapter to the AC line outlet.
- ❑ Insert the battery pack into the **CD-58** Desktop Charger while aligning the slots of the battery pack with the guides in the nest of the **CD-58**; refer to the following illustration for details on proper positioning of the

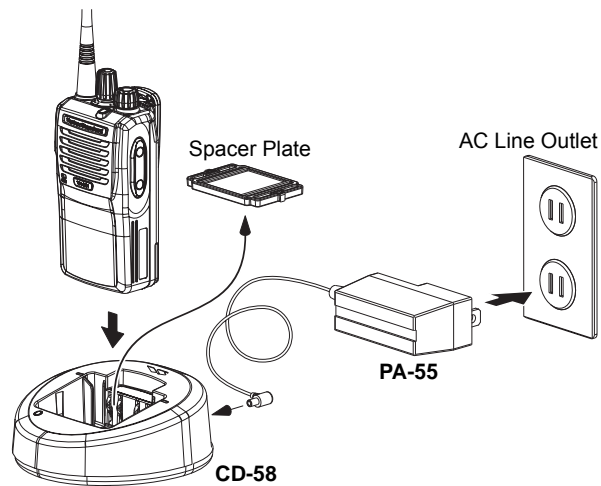

BEFORE YOU BEGIN

battery pack. If charging with the transceiver attached, turn the transceiver off. The antenna jack should be at the left side when viewing the charger from the front.

- ❑ If the battery pack is inserted correctly, the LED indicator will glow red. A fully-discharged battery pack will charge completely in 1.5 - 3.0 hours (depending on the battery pack being charged).
- ❑ When charging is completed, the LED indicator will change to green.
- ❑ Disconnect the battery pack from the **CD-58** Desktop Charger and unplug the **PA-55** AC Adapter from the AC line outlet.



1) Always use the Vertex Standard FNB-V133LI-UNI or FNB-V134LI-UNI Lithium-Ion Battery Pack.

2) Use only the Vertex Standard CD-58 Desktop Charger and the Vertex Standard PA-55 AC Adapter.

3) To reduce the risk of explosion, recharge the batteries outside of hazardous locations.

4) Perform the battery charging where the ambient temperature range +41 °F to +104 °F (+5 °C to +40 °C). Charging outside of this temperature range could cause damage to the battery pack.

5) Battery Pack should not be exposed to excessive heat such as sunshine, fire, or similar heat sources.

6) Risk of explosion exists if battery is replaced by an incorrect type. Refer to the enclosed instructions for disposal of used batteries.

7) For further details and cautions of the charging, refer to the Operating Manual of the CD-58 Desktop Charger.

Low Battery Indication

As the battery discharges during use, the voltage gradually becomes lower. When the battery voltage becomes too low, substitute a freshly charged battery and recharge the depleted pack. The LED indicator on the top of the radio will blink red when the battery voltage is low.

**CAUTION**

Danger of explosion if battery is replaced with an incorrect battery. Replace only with the same or equivalent type.

BEFORE YOU BEGIN

Belt Clip Installation and Removal

- ❑ To install the Belt Clip: align the Belt Clip to the groove of the Battery pack, then press the Belt Clip downward until it locks in place with a “Click.”
- ❑ To remove the Belt Clip: use a flat head screw driver to press the Belt Clip Tab away from the battery pack to unlock the Belt Clip, then slide the Belt Clip upward to remove it.

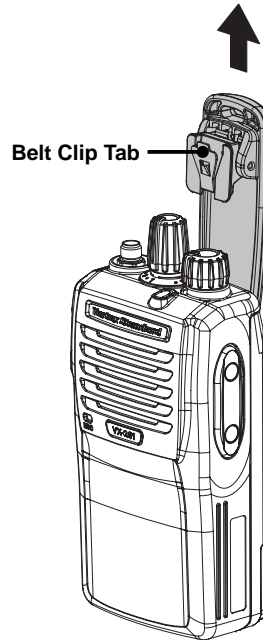
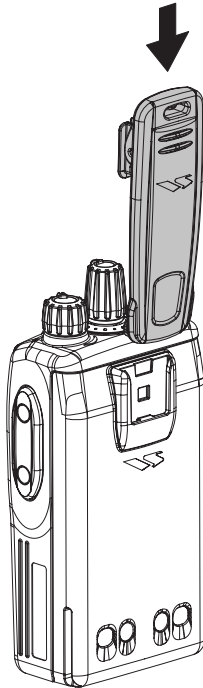

MIC/SP CAP Installation

Install the **MIC/SP** cap with the supplied screws.

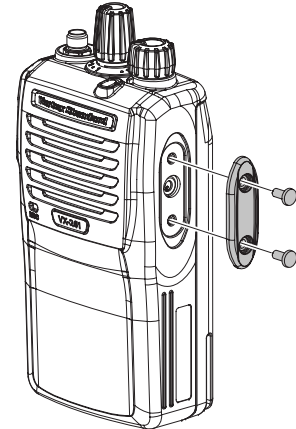

- ❑ Use only the supplied screws when install the **MIC/SP** cap.
- ❑ This radio does not keep the **Water Resistant Rating (IP55)** when the **MIC/SP** cap is not installed in the **MIC/SP** jack.

CONTROLS & CONNECTORS

CH (Channel) Selector

Antenna Jack

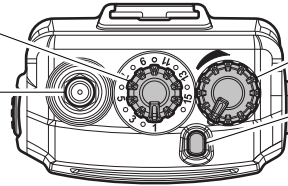

VOL (Volume)/PWR (Power) Knob

LED Indicator (Programmable)

Default settings are:

Steady Red: Transmitting in progress

Blinking Green: Busy Channel

Steady Green: Tone Squelch in defeated condition

Microphone

Speaker

PTT Switch

SIDE-1 Button

SIDE-2 Button

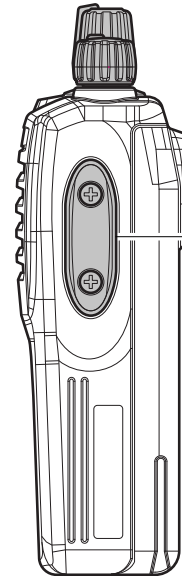
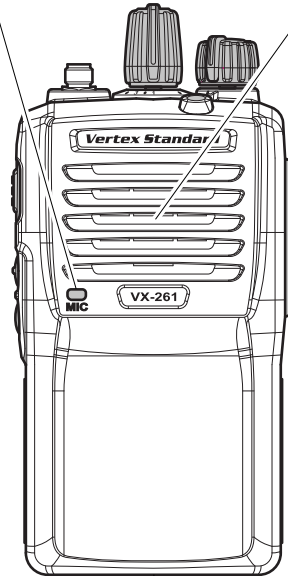
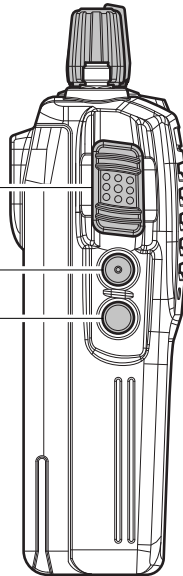

MIC/SP Jack
(External MIC/SP)

Battery Pack Latch

OPERATION

Preliminary Steps

- ❑ Install a charged battery pack onto the transceiver, as described previously.

- ❑ Screw the supplied antenna onto the Antenna jack.

It is not recommended to operate this transceiver without an antenna connected.

- ❑ If you have a Speaker/Microphone, we recommend that it not be connected until you are familiar with the basic operation of the **VX-261**. Refer to next page for more information about Speaker/Microphone usage.

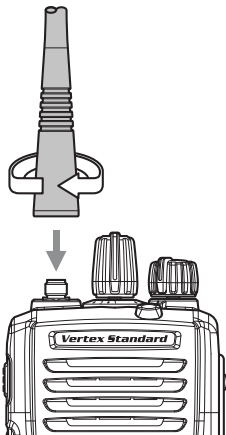

IMPORTANT NOTE

The water resistance rating of the transceiver (IP55) is assured only when the following conditions are met:

- ❑ Battery pack is attached to the transceiver;
- ❑ Antenna is connected to the antenna jack;
- ❑ **MIC/SP** cap is installed in the **MIC/SP** jack.
- ❑ Use of a speaker microphone in the **MIC/SP** jack negates the IP55 rating.

Operation Quick Start

- ❑ Turn the top panel's **VOL/PWR** knob clockwise to turn the radio on.

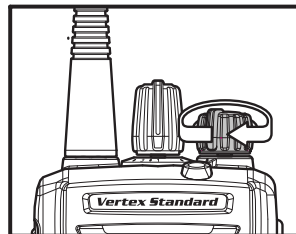

- ❑ Turn the top panel's **CH** Selector knob to choose the desired operating channel.

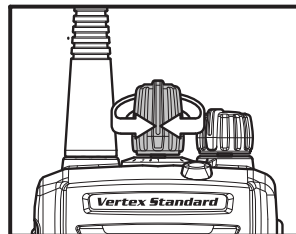

- ❑ Rotate the **VOL/PWR** knob to set the volume level. If no signal is present, press (or press and hold) the Programmable key (assigned to the “**SQL OFF**” function: Normally **SIDE-1** button); background noise will now be heard, and you may use this to set the **VOL/PWR** knob for the desired audio level. Press (or press and hold) the Programmable key again to quiet the

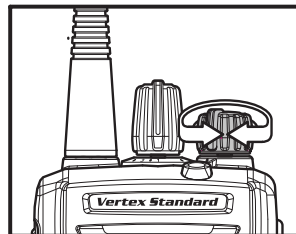

OPERATION

noise and resume normal (quiet) monitoring.

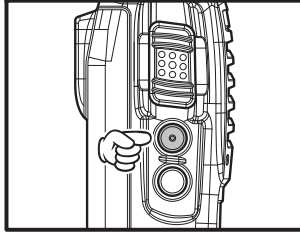

- ❑ To transmit, monitor the channel and make sure it is clear.

Press and hold the **PTT** switch. Speak into the microphone area of the front panel grille in a normal voice level. To return to the Receive mode, release the **PTT** switch.

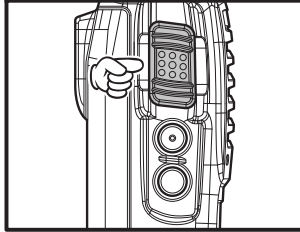

- ❑ Press (or press and hold) the **SIDE-1** or **SIDE-2** button to activate one of the pre-programmed functions which may have been enabled at the time of programming by the dealer. See the next chapter for details regarding feature availability for this radio.

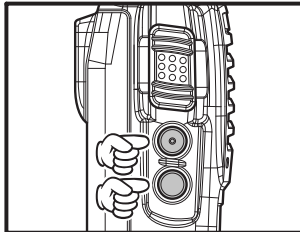

- ❑ If a Speaker/Microphone is available, remove the plastic cap and its two mounting screws from the right side of the transceiver, then align the connector of the Speaker/Microphone on the radio; secure the connector pin using the screws supplied with the Speaker/Microphone. Hold the speaker grille up next to your ear while receiving. To transmit, press the **PTT** switch on the Speaker/Microphone, just as you would on the main transceiver's body, and speak into the microphone on a normal voice level.

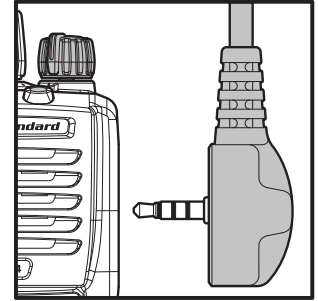

Note 1): Save the original plastic cap and its mounting screws. They should be reinstalled when not using the Speaker/Microphone.

2) When you press the PTT switch on the Speaker/Microphone, it disables the internal microphone, and vice versa.

- ❑ If the BCLO (Busy Channel Lockout) feature has been programmed on a channel, the radio will not transmit when a carrier is present. Instead, the radio will generate short beep three times. Release the **PTT** switch and wait for the channel to be clear of activity.

OPERATION

- ❑ If the BTLO (Busy Tone Lockout) feature has been programmed on a channel, the radio can transmit only when there is no carrier being received or when the carrier being received includes the correct tone (CTCSS tone or DCS code).

Automatic Time-Out Timer

If the selected channel has been programmed for automatic time-out, you must limit the length of each transmission. While transmitting, a beep will sound 10 seconds before time-out. Another beep will sound just before the deadline; the top panel's red LED ("TX" indicator) will disappear and transmission will cease soon thereafter. To resume transmitting, you must release the **PTT** switch and wait for the "penalty timer" to expire.

ADVANCED OPERATION

Programmable Key Functions

The **VX-261** provides two Programmable Function (**PF**) keys: **SIDE-1** and **SIDE-2** keys.

Both **PF** keys can be customized, via programming by your Vertex Standard dealer, to meet your communications/network requirements.

The possible **PF** key programming features are illustrated at the right, and their functions are explained beginning after next page. For further details, contact your Vertex Standard dealer.

For future reference, check the box next to each function that has been assigned to the **PF** key on your particular radio, and keep it handy.

FUNCTION	PROGRAMMABLE KEY (PRESS KEY / PRESS AND HOLD KEY)	
	SIDE-1	SIDE-2
None	/	/
Monitor	/	/
Monitor -Momentarily-	/—	/—
Low Power	/	/
SQL OFF	/	/
SQL OFF -Momentarily-	/—	/—
Beep OFF	/	/
Whisper	/	/
VOX	/	/
VOX Anti-Trip	/	/
Emergency	—/	—/
Lone Worker	/	/
PRI	/	/
Scan	/	/
Dual Watch	/	/
Follow-Me Scan	/	/
TA (Talk Around) Scan	/	/
Talk Around	/	/
Reset	/	/
Call 1	/	/
Call 2	/	/
Call 3	/	/
Speed Dial	/	/
Call	/	/
Duty	/	/
TX Save Disable	/	/
Lock	/	/

ADVANCED OPERATION

Description of Operating Functions

MONITOR

Press, (or press and hold), the assigned **PF** key to cancel any signaling features; the LED indicator will glow green.

MONITOR -MOMENTARILY-

Cancel any signaling features while pressing the assigned **PF** key.

LOW POWER

Press, (or press and hold), the assigned **PF** key to set the radio's transmitter to "Low Power" mode, thus extending battery life. Press, (or press and hold), the assigned **PF** key again to return to "Normal" transmit power when in RF impeding environments.

SQL OFF

Press, (or press and hold), the assigned **PF** key to open the SQL to hear background noise (unmute the audio).

SQL OFF -MOMENTARILY-

Opens the SQL to hear background noise (unmute the audio) while pressing the assigned **PF** key.

BEEP OFF

Press, (or press and hold), the assigned **PF** key to disable any radio beeps temporarily. Press again, (or press and hold again), the assigned **PF** key to enable any radio beeps.

WHISPER

Press, (or press and hold), the assigned **PF** key to increase the microphone gain; allowing the operator to speak in a low voice (whisper) temporarily when transmitting. Press again, (or press and hold again), the assigned **PF** key to resume normal microphone gain.

VOX (REQUIRES VOX COMPATIBLE HEADSET)

Press, (or press and hold), the assigned **PF** key to activate the VOX function; allowing hands-free, automatic activation of the transmitter, initiated by voice input into the microphone. You may disable the VOX function temporarily by pressing the **PTT** switch.

Press again, (or press and hold again), the assigned **PF** key to resume normal operation.

VOX ANTI-TRIP

Press, (or press and hold), the assigned **PF** key to toggle the VOX Anti-Trip feature "On" and "Off".

When the VOX Anti-Trip feature is set to "On", the transceiver does not activate a VOX transmission from picking up receive audio or from a radio alert tone (beep sound).

ADVANCED OPERATION

EMERGENCY

The **VX-261** includes an “Emergency” feature which may be useful for alerting another party monitoring on the same frequency as your transceiver’s channel. Please contact your Vertex Standard dealer for further details.

Press and hold the assigned **PF** key for a pre-programmed period to initiate an emergency call on the pre-defined channel.

To revive the radio from the Emergency mode, just press and hold again the assigned **PF** key or turn off the radio.

LONE WORKER

Press, (or press and hold), the assigned **PF** key to activate the Lone Worker feature. The Lone Worker feature is designed to emit an alarm for 30 seconds when the Lone Worker Timer (programmed by your Vertex Standard dealer) has expired.

Press again, (or press and hold again), the assigned **PF** key, the Lone Worker feature is disabled. If the user does not reset the timer by pressing the **PTT** switch, the radio switches to Emergency mode.

PRI

Press, (or press and hold), the assigned **PF** key to recall the pre-programmed Priority Channel by your Vertex Standard dealer directly.

SCAN

The Scanning feature is used to monitor multiple channels programmed into the transceiver. When scanning, the transceiver will check each channel for the presence of a signal and will stop on a channel if a signal is present.

To activate scanning:

- Press, (or press and hold), the assigned **PF** key to activate scan mode.
- The scanner will search the channels of the pre-programmed scan list, looking for an active channel. The radio will pause each time it finds a channel on which someone is speaking.
- Press again, (or press and hold again), the assigned **PF** key to disable scanning and receive the channel which was chosen when pressed the **PF** key.

Note: Your dealer may have programmed your radio to stay on one of the following channels if you press the **PTT** switch during scanning pause:

- “Scan Pause” channel (“Talk Back”)
- “Last Busy” channel
- “Priority” channel
- “User Programmed” channel (“Select Channel”)
- The channel which defined in the **CH** Selector knob.

ADVANCED OPERATION

DUAL WATCH

The Dual Watch feature is similar to the SCAN feature, except that only two channels are monitored:

- The current operating channel
- The Priority channel.

To activate Dual Watch:

- Press, (or press and hold), the assigned **PF** key to activate the Dual Watch feature.
- The scanner will search the two channels and pause when it finds a transmission on either channel.

To stop Dual Watch:

- Press, (or press and hold), the assigned **PF** key to disable the Dual Watch feature. The radio receives the channel which was selected by the **CH** Selector knob.

FOLLOW ME SCAN

The Follow Me Scan feature checks a user-assigned priority channel in addition to the channels previously pre-programmed into a radio's scan list. For example, if only Channels 1, 3, and 5 (of the 8 available channels) are designated for "Scanning", the user may assign Channel 2 as the "user-assigned" priority channel via the Follow Me Scan.

To activate Follow Me Scan, first select the channel you want to designate as the "user-assigned priority channel" by positioning the **CH** Selector knob on the desired "priority" channel. Next, press, (or press and hold), the assigned **PF** key. Finally, rotate the **CH** Selector knob to the desired "operating channel".

The scanner will search the two channels (user-assigned priority channel and operating channel) and pause when it finds a transmission on either channel.

ADVANCED OPERATION

TA (TALK AROUND) SCAN

Press, (or press and hold), the assigned **PF** key to toggle the TA Scan feature “On” and “Off”.

When operating on a duplex channel system (for example, a repeater station), TA Scan allows the transceiver to search both transmit and receive frequencies on your duplex system.

When a signal is encountered on the receive frequency, the transceiver will pause until the signal disappears. When a signal is encountered on the transmit frequency, the transceiver will check for activity on the receive frequency every few seconds (interval programmed by your Vertex Standard dealer).

Note: The TA Scan feature does not activate on a Simplex Channel.

TALK AROUND

Press, (or press and hold), the assigned **PF** key to activate the Talk Around feature when you are operating on duplex channel systems (separate receive and transmit frequencies, utilizing a “repeater” station). The Talk Around feature allows you to bypass the repeater station and talk directly to a station that is nearby. This feature has no effect when you are operating on “simplex” channels, where the receive and transmit frequencies are already the same.

Note that your dealer may have mode provision for “Talk Around” channels by programming “repeater” and “Talk Around” frequencies on two adjacent channels. If so, the key may be used for one of the other Pre-Programmed Functions.

Note: The Talk Around feature does not activate on a Simplex Channel.

RESET

Press (or press and hold) the assigned **PF** key to reset the RFC (Ready for Communication) condition.

CALL 1 TO CALL 3

Press, (or press and hold), the assigned **PF** key to send a pre-programmed 5-Tone call signal.

ADVANCED OPERATION

SPEED DIAL

Your Vertex Standard dealer may have pre-programmed Auto-Dial telephone number memories into your radio.

To dial a number:

Press, (or press and hold), the assigned **PF** key to send a pre-defined DTMF tone. The DTMF tones sent during the dialing sequence will be heard in the speaker.

CALL

Press, (or press and hold), the assigned **PF** key to send a pre-programmed 2-Tone encode code.

DUTY

Press, (or press and hold), the assigned **PF** key to toggle the Duty function of the 2-Tone or 5-Tone “On” and “Off”.

When the Duty function is set to “On”, the user will always hear (depending on the sub-audio signaling) all traffic on the paging channel. The radio will sound the paging alert when it receives the programmed 2-Tone or 5-Tone.

When the Duty function is set to “Off”, the user will NOT hear normal radio traffic on the paging channel. The radio will sound the paging alert and unmute only when it receives the programmed 2-Tone or 5-Tone.

TX SAVE DISABLE

The Transmit Battery Saver helps extend battery life by reducing transmit power when a very strong signal from an apparently nearby station is being received. Caution is advised when using this feature, as your transmission power could degrade the audio heard by the receiving radios in your communication path.

Press, (or press and hold), the assigned **PF** key to disable the Transmit Battery Saver, if you are operating in a location where high power is almost always needed.

Press again, (or press and hold again), the assigned **PF** key, the Transmit Battery Saver activates to reduce the transmit power when a very strong signal from an apparently nearby station is being received.

LOCK

Press (or press and hold) the assigned **PF** key to lock the **CH** Selector knob, Programmable keys, and **PTT** switch.

LOCK

In order to prevent accidental channel change or inadvertent transmission, various aspects of the **CH** Selector knob, Programmable keys, and **PTT** switch may be locked. The precise lockout configuration is programmed by your Dealer.

To activate the key locking, turn the radio off. Then, press and hold the **PTT** and **SIDE-2** key while turning the radio on again.



To cancel the key locking, repeat this process.

ARTS™ (AUTO RANGE TRANSPOND SYSTEM)

This system is designed to inform the operator when you and another ARTS™-equipped transceivers and stations are within communication range using the DCS Encoder/Decoder.

During ARTS™ operation, when the radio receives an incoming ARTS™ signal, a short beep will sound. If you move out of range for more than two minutes, your radio senses that no signal has been received; a short triple-beep will sound. If you move back into communication range, as soon as the other station transmits, a short beep will sound again.

OPTIONAL ACCESSORIES

FNB-V133LI-UNI	7.4V DC  , 1380 mAh Li-Ion Battery Pack	ATV-8A	VHF Antenna (134-151 MHz)
FNB-V134LI-UNI	7.4V DC  , 2300 mAh Li-Ion Battery Pack	ATV-8B	VHF Antenna (150-163 MHz)
CD-58	Desktop Charger	ATV-8C	VHF Antenna (161-174 MHz)
PA-55	AC Adapter for CD-58	ATV-6XL	VHF Antenna (Untuned)
VAC-UNI	Desktop Charger (CD-58 + PA-55)	ATU-6A	UHF Antenna (400-430 MHz)
VAC-6058	Multi-Unit Charger	ATU-6B	UHF Antenna (420-450 MHz)
MH-37_{A4B-1}	Earpiece Microphone	ATU-6C	UHF Antenna (440-470 MHz)
MH-45_{B4B}	Noise Cancelling Speaker Microphone	ATU-6D	UHF Antenna (450-490 MHz)
MH-100	Receive Only Earpiece (for MH-45 _{B4B} /-360S/-450S)	ATU-6F	UHF Antenna (490-520 MHz)
MH-101_{A4B}	1 Wire Surveillance Kit	CN-3	Antenna Adapter
MH-102_{A4B}	2 Wire Surveillance Kit	CLIP-20	Belt Clip
MH-360S	Compact Speaker Microphone	CE150	PC Programming Software
MH-450S	Speaker Microphone	FIF-12	USB Programming Interface
VH-150A	Behind Type VOX Compatible Microphone	CT-106	Connection Cable for FIF-12
VH-150B	Over the Head VOX Compatible Microphone	CT-27	Radio to Radio Cloning Cable
VCM-5	Vehicular Charger Mounting Adapter for CD-58		

Availability of accessories may vary; some accessories are supplied standard per local requirements, others may be unavailable in some regions. Check with your Vertex Standard Dealer for changes to this list.

WARRANTY POLICY

Vertex Standard warrants, to the original purchaser only, its Vertex Standard manufactured communications products against defects in materials and workmanship under normal use and service for a given period of time from the date of purchase.

Limited Warranty Details:

- North America customers (USA and Canada): <http://www.vertexstandard.com/lmr/warranty-terms.aspx>
- Customers outside of North America: contact the authorized Vertex Standard distributor in your country.

DISPOSAL OF YOUR ELECTRONIC AND ELECTRIC EQUIPMENT

Products with the symbol (crossed-out wheeled bin) cannot be disposed as household waste.

Electronic and Electric Equipment should be recycled at a facility capable of handling these items and their waste by products.

In EU countries, please contact your local equipment supplier representative or service center for information about the waste collection system in your country.



Part 15.21: Changes or modifications to this device not expressly approved by Vertex Standard could void the user's authorization to operate this device.



No portion of this manual may be reproduced without the permission of Vertex Standard LMR, Inc.

Vertex Standard is a trademark of Vertex Standard LMR, Inc.
All other trademarks are the property of their respective owners.

©2016 Vertex Standard LMR, Inc.
All rights reserved.

Vertex Standard LMR, Inc.
4-6-8 Shibaura, Minato-ku, Tokyo 108-0023, Japan

